

Tapping for High Performance Machinery





SYNCROLIZE SYSTEM

page 6-9



TENSION & COMPRESSION SYSTEM

page 10-11



RIGID SYSTEM

page 12-13



TAP ADAPTERS Torque Control & Rigid

page 14-15



Tapping Terminology

Axial Feed

A thread is an inclined plane that is rolled into a cylinder. The distance between a point on the plane and the point directly above or below it is the pitch of the thread. To produce quality thread the tap must be fed into the work piece precisely on pitch. A tap is the only metalworking tool in which the feed rate and the spindle speed must be perfectly matched. For each revolution the tap makes it must advance the distance of the pitch. Retarding or accelerating the taps entrance and exit will cause the tap to be pushed or pulled, producing a defective thread.

Tension/Compression Stroke

A tap is a precision ground cutting tool. Because not all machine tools can synchronize speed to feed, a tension and compression floating tapping head is utilized. This allows the tap to pull itself in to the workpiece on entrance, and follow the pitch exiting the workpiece allowing the tap to be pulled from the workpiece, thus producing a quality thread.

Torque Control

Torque control is the ability to cause the tap to stop rotating when a predetermined force or pressure is reached. This often happens when tapping blind holes where chip build-up blocks the hole. Without torque control, the tap can break, resulting in excessive tooling cost, and a possible defective or an unusable workpiece. To prevent this problem when tapping blind holes, choose SCM's tap adapters with the torque control clutch feature.

Radial Float

Radial float allows for misalignment between the tap and the hole to be tapped. This also allows the tap to follow a hole which has not been drilled straight.

Axial Compression

The compression stroke cushions the tap as it enters the workpiece. This feature also allows holes to be re-tapped. This is particularly helpful when setting up a job. The compression stroke to maximize depth control on Size #1 is adjustable from 45 ft/lbs. to 100 ft/lbs. Size #2 is adjustable from 95 ft/lbs. to 360 ft/lbs.

Syncrolize

Modern machine tools offer the capability of synchronizing the spindle rotation and spindle feed. This means the compression and tension stroke found in traditional tapping heads is not needed. The newer processors allow for the use of a lower cost holder since the axial float mechanism is not needed. It also offers the advantage of tapping at higher cycle speeds. SCM recommends the Syncrolize tapping chuck for synchronized tapping. It offers 0.039" tension stroke, 0.008" compression stroke, & 0.0001" radial float. This combination results in perfect hole line-up, reduced cycle times, quality threads and longer tap life (up to 4 times) with a lower cost tapping head.



More than 40 years of
Patents and Innovation.

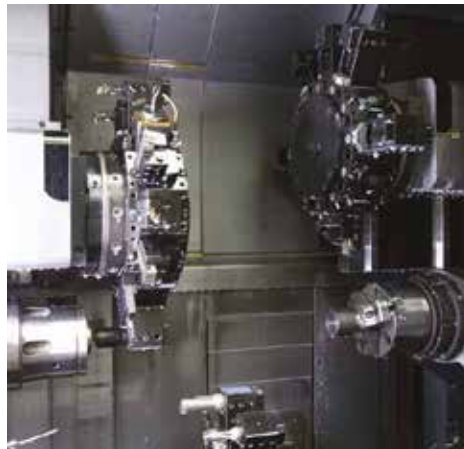

ISO 9001
BUREAU VERITAS
Certification

Tapping for High Performance Machinery



MATERIAL

Tapping Toolholders, from SCM are manufactured from 18 NiCrMo5. This high quality Nickel - Chrome alloy steel is used to provide maximum performance and life of the toolholder.

HEAT TREAT

All tapered shanks are case hardened to 58-60 Rockwell "C" and have a core hardness of 40-45 Rockwell "C". The case hardness is designed to provide the maximum toolholder life without damaging the machine spindle.

TAPER END

All tapers manufactured by SCM are 100% controlled and manufactured in accordance to the AT3 tolerance specification or better. The taper roundness tolerance is held at .00008" or better. Every taper that SCM manufactures is inspected and evaluated with 3 point contact measurement which exceeds the 2 point contact as required by the AT3 specification.

QUALITY CONTROL

SCM has a significant investment in inspection equipment and processes to ensure the quality of every tool that it manufactures. All high performance tools are 100% inspected and evaluated for T.I.R. and balance. A document of certification is provided that states the actual measurements. All products are manufactured on modern, well maintained machinery by trained and skilled operators.

SAFETY WARNING SCM-America products are engineered and manufactured with safety in mind. The heat treat specifications exceed or meet all standards. All of the products manufactured by SCM-America are designed to perform without any undue safety issues when caution, common sense and proper safety practices are followed. The use of cutting tools and toolholders is safe when proper application and protection guidelines are observed. Even when these proper precautions are taken, it is possible that fragments of a cutting tool, cutting material, or holding device may be thrown at a very high rate of speed and have potential to cause severe bodily harm. It is imperative that general safety precautions and safety glasses be used at all times.

SYNCROLIZE SYSTEM

For machines capable of synchronous tapping

The CNC synchronizes tap rotation and machine feed according to the pitch of the tap.

Capable of higher speeds

Significantly increased tool life

Ideal for high performance and carbide taps.

The SCM Syncrolize System

A new generation system, patented by SCM, using a quick change tapping chuck and tap adapter. The micro-compensation, rigidity and high precision alignment significantly increases tap-hole yields and tap life with improved thread quality.

Much Higher Axial and Radial Force

The first threads of the tap have a high concentration of both axial and radial force at the moment of reversal.

Increased Precision and Tool Life

SCM's micro-compensation technology minimizes tap damage which compromises precision and tool life.

Differentiated Compensation to Reduce Axial and Radial Forces

The compensation in extension is higher than that in compression. In extension axial force is reduced during reversal; in compression the depth of the thread is guaranteed.

Size 1

#0 to 1/2"
M1.6 – M12
ER 16

Size 2

3/8" to 5/8"
M10 – M16
ER 25

Size 3

5/8" to 1"
M16 – M25
ER 40



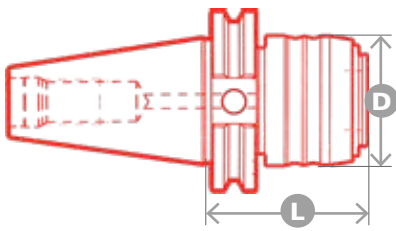

CAT

EDP	Part	Shank	(D)	(L)	Size	Collet Size	Quick Change Collet Chucks
13004B	23400-40CAT	CAT40	1.732"	2.756"	1	ER16	23410-ER16
13005B	23400-50CAT	CAT50	1.732"	2.756"	1	ER16	23410-ER16
13013B	23600-40CAT	CAT40	2.362"	3.543"	2	ER25	23610-ER25
13014B	23600-50CAT	CAT50	2.362"	3.543"	2	ER25	23610-ER25
13320B	23800-50CAT	CAT50	3.425"	4.528"	3	ER40	23810-ER40

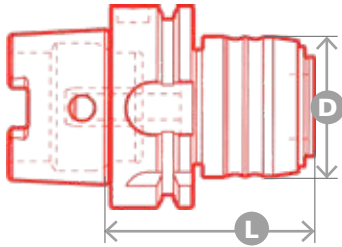

HSK

EDP	Part	Shank	(D)	(L)	Size	Collet Size	Quick Change Collet Chucks
13002B	23400-H63A	HSK63	1.693"	2.520"	1	ER16	23410-ER16
13003B	23400-H100A	HSK100	1.693"	2.756"	1	ER16	23410-ER16
13011B	23600-H63A	HSK63	2.362"	3.819"	2	ER25	23610-ER25
13012B	23600-H100A	HSK100	2.362"	3.583"	2	ER25	23610-ER25
13090B	23800-H100A	HSK100A	3.425"	4.528"	3	ER40	23810-ER40

Stock standard chuck styles listed above. Many more sizes and shank styles are available by special order, including: **Straight Shank, BT, CAPTO™, HSK Form E, ISO 69871, MAS-BT, DIN, VDI, Kennametal™, Kennametal™-Mazak™.** Contact your Customer Service Representative today for more information.

QUICK
CHANGE
COLLETS

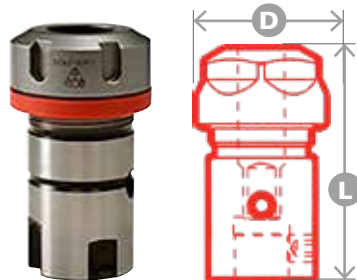

EDP	Part	Size	(D)	(L)
13600A	23410-ER16	ER16	1.102"	0.945"
13602A	23610-ER25	ER25	1.654"	1.102"
14415A	23810-ER40	ER40	2.480"	1.260"



REPLACEMENT
NUTS

EDP	Size	Type
60022A	ER16	Hex
14962A	ER25	Standard
14964A	ER40	Standard

SYNCROLIZE SYSTEM

EXTENSION SYSTEM

ER Terminal

EDP	Part	(L)	Size
13103B	42147/ER16	1.969"	1
13107B	42247/ER25	3.110"	2
13304B	42347/ER40	3.661"	3

Extensions

EDP	Part	(L)	Size
13101B	42150/25	0.984"	1
13102B	42150/50	1.969"	1
13105B	42250/50	1.969"	2
13106B	42250/100	3.937"	2
13300B	42350/100	3.937"	3

Extended Tap Adapter Body

EDP	Part	(L)	Size
13100B	23411-MOD	0.197"	1
13104B	23611-MOD	0.276"	2
13303B	23811-MOD	0.078"	3



Positive Drive

ER COLLETS

Inch	Metric	Shank	Size 1 ER16 #0 to 1/2"	Size 2 ER25 3/8 to 5/8"	Size 3 ER40 5/8 to 1"
#0-6	M1.6-M3.5	0.141"	X13700A		
#8	M4	0.168"	X13701A		
#10	M5	0.194"	X13702A		
#12	---	0.220"	X13703A		
1/4"	M6	0.255"	X13704A		
5/16"	M7, M8	0.318"	X13705A		
3/8"	M10	0.381"	X13706A	X13723A	
7/16"	M10	0.323"	X13708A	X13726A	
1/2"	M12	0.367"	X13707A	X13724A	
9/16"	M14	0.429"		X13727A	
5/8"	M16	0.480"		X13725A	X13754A
11/16"	M18	0.542"			X13755A
3/4"	---	0.590"			X13757A
13/16"	M20	0.652"			X13758A
7/8"	M22	0.697"			X13760A
15/16"	M24	0.760"			X13762A
1"	M25	0.800"			X13763A
1/8" NPT	---	0.322"			X13753A
1/4" NPT	---	0.421"			X13756A
1/2" NPT	---	0.515"			X13759A
3/8" NPT	---	0.531"			X13761A



MICRO-COMPENSATION SPRING

An exclusive Micro-Compensation Spring combined with a Rubber Disc which, when compressed, guarantees reliability and chuck life by absorbing the force of the tap in extension.



Rubber Disc
For a guaranteed depth of thread.



Micro-Compensation Spring
Spring Steel guaranteed for maximum spring life and function.

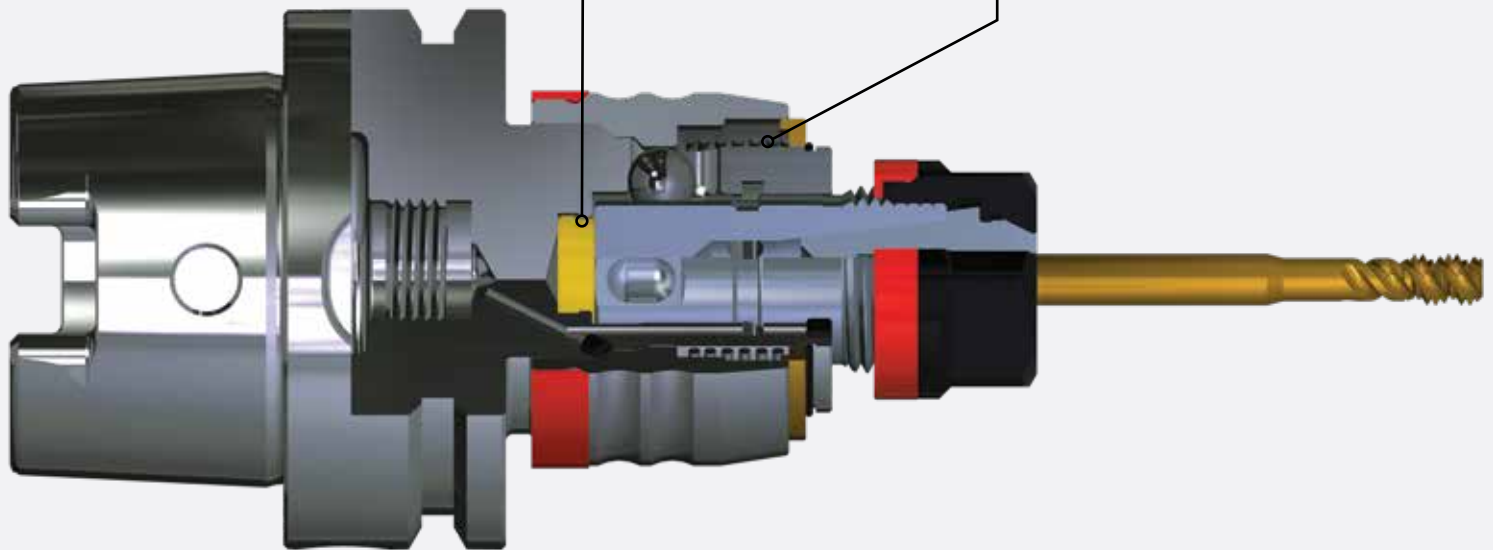

THE LEAST AXIAL FORCE

Comparison

During synchronized tapping operations, the SCM Syncrolize produces the least axial force, and the best tap life.

SAVES TIME AND MONEY

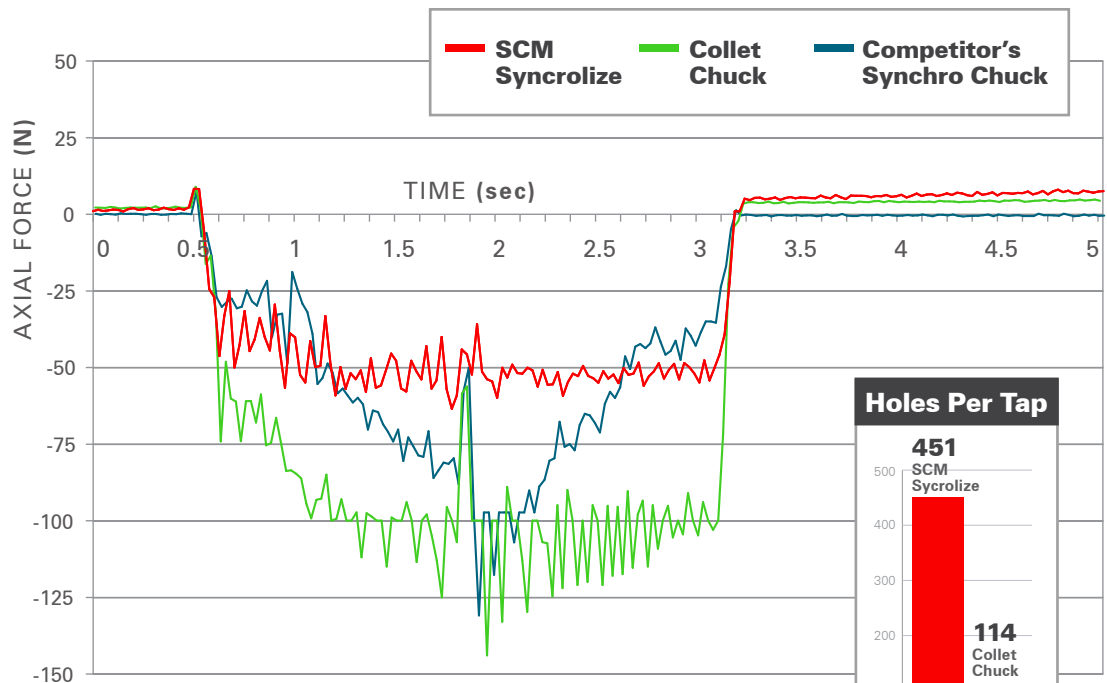

Increased Tap Life more than **400%**

Machine Used

Mori Seiki® SH40

Tap Used

UFS K82M6X TXC LA030310F
(Vt=12m/min Av=1mm/rev prof=12mm)

Material

AISI 304 - 1,3401 Rolled steel
(150 x 100 x 15 mm)

Orientation

Horizontal



TENSION & COMPRESSION SYSTEM

Compensates for spindle over-rotation and prevents cross-threading

Softer entry and exit of the hole produces a higher quality thread.

Significantly increased tool life

Uses quick change tap adapters

Large Axial Stroke

Offsets difference between tap pitch and machine feed

Ball Retainer

A smooth axial compensation for perfect tolerance on threads

Controlled Tapping Depth

Increase entry pressure and obtain controlled tapping depth ± 0.1



Size 1

#0 to 9/16"
M1.6 - M14

Size 2

5/16" to 7/8"
M8 - M22

Size 3

1/2" to 1-3/8"
M12 - M33

Size 4

1-1/2" to 1-7/8"
M36 - M42

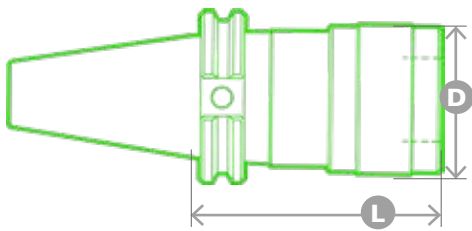

CAT

EDP	Part	Shank	(D)	(L)			Size
					Tension	Compression	
11050B	32400/40CAT	CAT40	1.496"	3.012"	0.35"	0.35"	1
11051B	32400/50CAT	CAT50	1.496"	3.012"	0.35"	0.35"	1
11052B	32600/40CAT	CAT40	2.165"	3.940"	0.59"	0.59"	2
11053B	32600/50CAT	CAT50	2.165"	3.898"	0.59"	0.59"	2
11054B	32800/40CAT	CAT40	3.110"	5.472"	0.94"	0.94"	3
11055B	32800/50CAT	CAT50	3.110"	5.276"	0.94"	0.94"	3
11056B	32900/40CAT	CAT40	3.858"	6.063"	1.02"	1.02"	4
11057B	32900/50CAT	CAT50	3.858"	5.809"	1.02"	1.02"	4

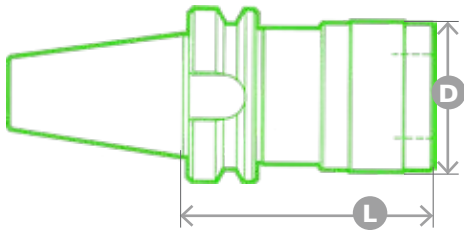

BT

EDP	Part	Shank	(D)	(L)			Size
					Tension	Compression	
11200B	32400/30BT	BT30	1.496"	2.480"	0.35"	0.35"	1
11201B	32400/40BT	BT40	1.496"	2.677"	0.35"	0.35"	1
11203B	32600/30BT	BT30	2.165"	3.780"	0.59"	0.59"	2
11204B	32600/40BT	BT40	2.165"	3.661"	0.59"	0.59"	2

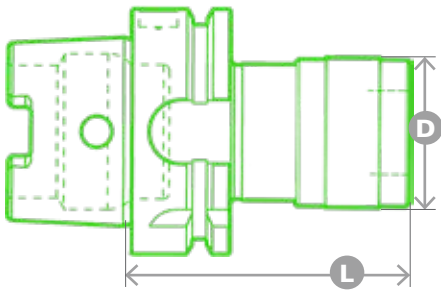

HSK

EDP	Part	Shank	(D)	(L)			Size
					Tension	Compression	
11401B	34400/H63A	HSK63A	1.614"	2.835"	0.29"	0.29"	1
11403B	34400/H100A	HSK100A	1.614"	3.150"	0.29"	0.29"	1
11405B	34600/H63A	HSK63A	2.362"	4.331"	0.39"	0.39"	2
11408B	34800/H63A	HSK63A	3.386"	5.551"	0.69"	0.69"	3
11410B	34800/H100A	HSK100A	3.386"	5.669"	0.69"	0.69"	3

HSK S SERIES: TENSION STROKE ONLY

EDP	Part	Shank	(D)	(L)			Size
					Tension	Compression	
11364B	34400/H63AS	HSK63A	1.614"	2.657"	0.47"	N/A	1
11366B	34400/H100AS	HSK100A	1.614"	2.972"	0.47"	N/A	1
11370B	34600/H63AS	HSK63A	2.362"	4.094"	0.63"	N/A	2
11372B	34600/H100AS	HSK100A	2.362"	3.701"	0.63"	N/A	2
11373B	34800/H63AS	HSK63A	3.386"	5.118"	1.18"	N/A	3
11375B	34800/H100AS	HSK100A	3.386"	5.217"	1.18"	N/A	3

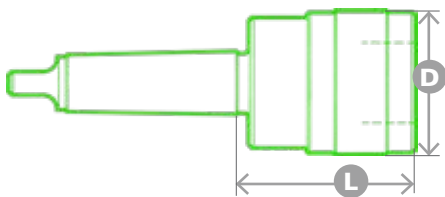

MORSE TAPER

EDP	Part	Shank	(D)	(L)			Size
					Tension	Compression	
12025B	32400/2	MT2	1.496"	1.811"	0.35"	0.35"	1
12026B	32400/3	MT3	1.496"	1.811"	0.35"	0.35"	1
12023B	32600/3	MT3	2.165"	2.717"	0.59"	0.59"	2
12028B	32600/4	MT4	2.165"	2.756"	0.59"	0.59"	2
12024B	32800/4	MT4	3.110"	4.252"	0.94"	0.94"	3
12030B	32800/5	MT5	3.110"	4.055"	0.94"	0.94"	3
12031B	32900/5	MT5	3.858"	4.567"	1.02"	1.02"	4

Stock standard chuck styles listed above. Many more sizes and shank styles are available by special order, including: **Straight Shank, Cylindrical Shank, Morse Cone, ISO DIN 2080, VDI, CAPTO™, DIN 1835 B+E.**

Contact your Customer Service Representative today for more information.

RIGID SYSTEM

For fast, rigid tapping

No axial compensation

Uses quick change tap adapters

Faster and Easier

Than using a standard collet chuck

Size 1

#0 to 9/16"
M1.6 - M14

Size 2

5/16" to 7/8"
M8 - M22

Size 3

1/2" to 1-3/8"
M12 - M33



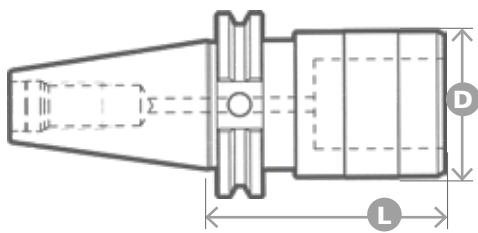

CAT

EDP	Part	Shank	(D)	(L)	Size
11100B	21480/40CAT	CAT40	1.299"	2.953"	1
11101B	21480/50CAT	CAT50	1.299"	2.953"	1
11102B	21680/40CAT	CAT40	1.969"	3.386"	2
11103B	21680/50CAT	CAT50	1.969"	3.858"	2
11104B	21880/40CAT	CAT40	2.835"	4.803"	3
11105B	21880/50CAT	CAT50	2.835"	4.803"	3

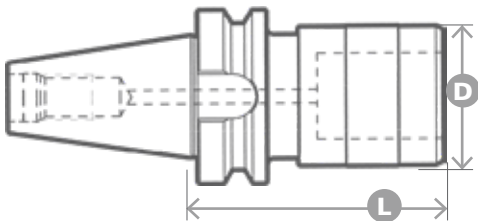

BT

EDP	Part	Shank	(D)	(L)	Size
12174B	21480/30BT	BT30	1.299"	2.441"	1
12128B	21480/40BT	BT40	1.299"	2.638"	1
12175B	21680/30BT	BT30	1.969"	3.346"	2
11181B	21680/40BT	BT40	1.969"	3.543"	2
11182B	21880/40BT	BT40	2.835"	4.606"	3

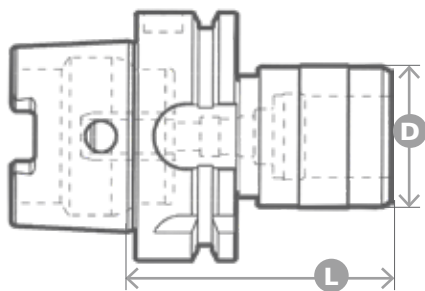

HSK

EDP	Part	Shank	(D)	(L)	Size
12152B	21480/H63A	HSK63A	1.299"	2.480"	1
12154B	21480/H100A	HSK100A	1.299"	2.717"	1
12157B	21680/H63A	HSK63A	1.969"	3.504"	2
12159B	21680/H100A	HSK100A	1.969"	3.622"	2
12160B	21880/H63A	HSK63A	2.835"	5.079"	3
12162B	21880/H100A	HSK100A	2.835"	4.567"	3

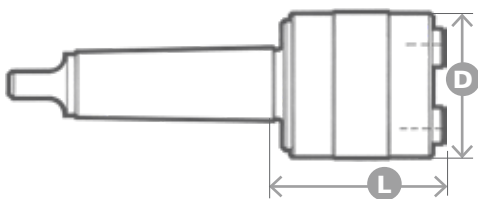

MORSE TAPER

EDP	Part	Shank	(D)	(L)	Size
12178B	21480/2	MT2	1.299"	1.772"	1
12179B	21480/3	MT3	1.299"	1.772"	1
12180B	21680/2	MT2	1.969"	2.402"	2
12181B	21680/3	MT3	1.969"	2.402"	2
12183B	21880/4	MT4	2.835"	3.622"	3

Stock standard chuck styles listed above. Many more sizes and shank styles are available by special order, including: **Straight Shank, ISO 69871, MAS-BT, ISO DIN 2080, Morse Cone, Cylindrical Shank.**

Contact your Customer Service Representative today for more information.

TAP ADAPTERS

Rigid

Rigid tap adapters are well suited for through holes and tapping in non-ferrous materials.



TAP ADAPTERS

Torque Control

Protects your taps and workpieces from tap breakage. The best solution for blind hole tapping and where chip evacuation is a concern.



TAP ADAPTERS

Rigid Tap Sizes

Torque Control Sizes

ANSI	ISO	STI	1	2	3	4	1	2	3
#0 - 6	M1.6-M3.5	#1- 4	11600B				11800B		
#8	M4	#5	11602B				11801B		
#10	M5	#6	11604B				11802B		
#12	---	#8	11605B				11803B		
1/4"	M6	#10	11606B				11804B		
5/16"	M8	1/4"	11607B	11614B			11805B	11811B	
3/8"	M10	5/16"	11608B	11615B			11806B	11812B	
7/16"	M11	---	11611B	11616B			11807B	11813B	
1/2"	M12	3/8"	11612B	11617B	11627B		11808B	11814B	11825B
9/16"	M14	7/16"	11613B	11618B	11628B		11809B	11815B	11826B
5/8"	M16	1/2"		11619B	11629B			11816B	11827B
11/16"	M18	9/16"		11620B	11630B			11817B	11828B
3/4"	---	5/8"		11621B	11631B			11818B	11829B
13/16"	M20	---		11622B	11632B			11819B	11830B
7/8"	M22	3/4"		11623B	11633B			11820B	11831B
15/16"	M24	M20			11634B				11833B
1"	M25	7/8"			11635B				11834B
1-1/16"	M27	M24			11636B				11835B
1-1/8"	M27	M24			11636B				11835B
1-3/16"	M30	1"			11637B				11836B
1-1/4"	M30	1"			11637B				11836B
1-5/16"	M33	1-1/8"			11638B				11837B
1-3/8"	M33	1-1/8"			11638B				11837B
1-1/2"	---	---				11643B			
1-7/16"	M36	1-1/4"				11643B			
1-5/8"	M39	1-3/8"				11644B			
1-3/4"	M42	1-1/2"				11645B			
1-7/8"	---	---				11646B			
1/8" NPT	---	---	11609B				11810B		
1/4" NPT	---	---		11624B				11822B	
3/8" NPT	---	---		11625B	11639B			11823B	11838B
1/2" NPT	---	---		11626B	11640B			11824B	11839B
3/4" NPT	---	---			11641B				11840B
1" NPT	---	---			11642B				11841B

TAP ADAPTER ACCESSORIES



Reduction Cups

EDP	Size
10071A	1 - 0
10072A	2 - 1
10073A	3 - 1
10074A	3 - 2



ER Collet Chuck Adapters

EDP	Size
11750A	1 - ER16
11751A	2 - ER25



Tap Adapter Extension

EDP	Size
10080A	Size 1 #10 - 9/16"



scm-america.com



**QUALITY TOOL
IMPORTS LLC**

QTI is committed to providing our supply channel partners and end user customers the best drilling and tapping products in the world. If you have any suggestions on how we can do better, please don't hesitate to contact me!

-Joshua Nourse, President

www.qtimports.com

sales@qtimports.com

(220) 666-0911

601 Pittsburgh Avenue C

Mount Vernon, OH 43050